

RLS 310÷610/M MX SERIES

The RLS/M MX series of burners are characterised by a modular monoblock structure that means all necessary components can be combined in a single unit thus making installation easier, faster and, above all, more flexible.

The series covers a firing range from 1200 to 6155 kW, and it has been designed for use in hot water boilers, overheated water boilers as well as steam boilers.

Operation can be "two stage progressive" or alternatively "modulating", for both fuels, light oil and gas, with the installation of a PID logic regulator .

The mechanical cam device of regulation allows to catch up a high modulation ratio on all firing rates range. The burners can, therefore, supply with precision the demanded power, guaranteeing a high efficiency system level and the stability setting, obtaining fuel consumption and operating costs reduction.

The combustion head guarantees reduced polluting emissions. An exclusive design guarantees low sound emissions, low electrical consumption, easy use and maintenance.



RLS 310/M MX	600/1200 ÷ 3600 kW
RLS 410/M MX	640/1500 ÷ 4200 kW
RLS 510/M MX	660/1800 ÷ 5170 kW
RLS 610/M MX	1000/2200 ÷ 6155 kW

Low NOx Modulating Dual Fuel Burners

RLS 310÷610/M MX SERIES

FIRING RATES

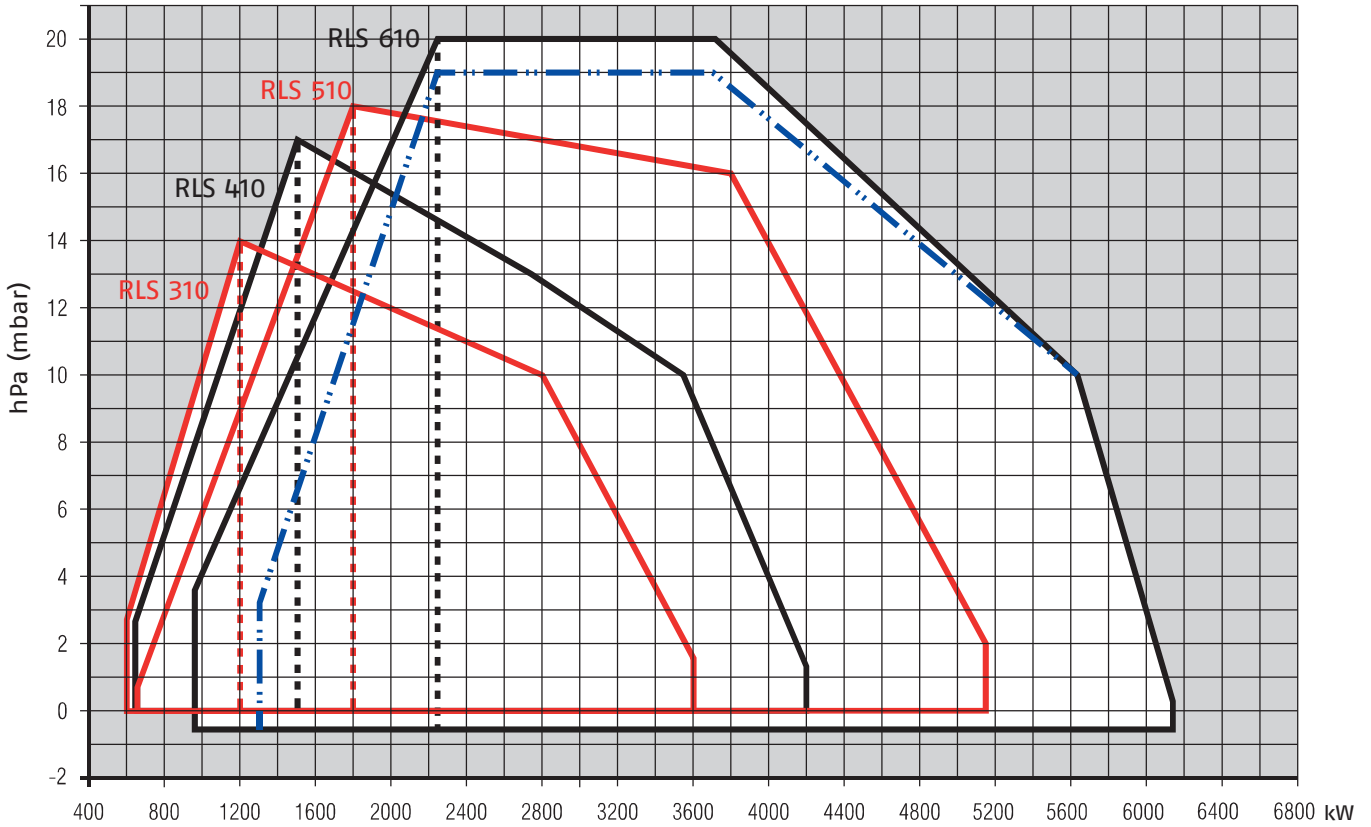

Useful working field
for choosing the
burner



Modulation range

Test conditions
conforming to EN267-
EN676
Temperature: 20°C
Pressure: 1013,5 mbar
Altitude: 0 m a.s.l.



Light-oil
firing rate
for RLS 610 model
(min. output 1.300 kW)

Overall dimensions (mm)

BURNER

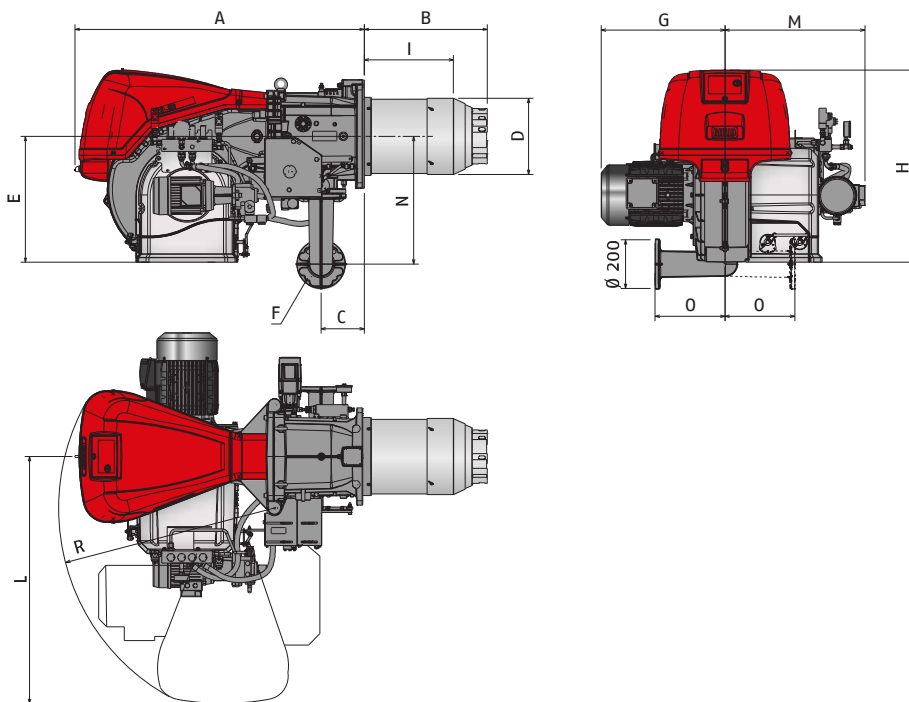

MODEL	A	B	C	D	E	F	G	H	I	L	M	N	O	R
► RLS 310/M MX	1190	507	178	313	520	DN65	571	790	365	1015	595	528	290	890
► RLS 410/M MX	1190	507	178	313	520	DN65	530	790	365	1015	595	528	290	890
► RLS 510/M MX	1190	507	178	313	520	DN65	530	790	365	1015	595	528	290	890
► RLS 610/M MX	1190	510	178	336	520	DN65	580	790	351	1015	595	528	290	890

BURNER - BOILER MOUNTING FLANGE

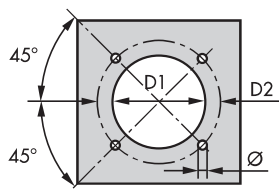

MODEL	D1	D2	Ø
► RLS 310/M MX	335	452	M18
► RLS 410/M MX	335	452	M18
► RLS 510/M MX	335	452	M18
► RLS 610/M MX	350	452	M18

PACKAGING

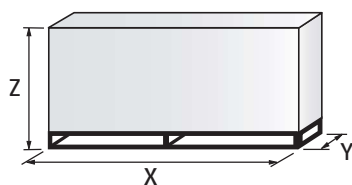

MODEL	X	Y	Z	kg
► RLS 310/M MX	2040	1180	1125	300
► RLS 410/M MX	2040	1180	1125	300
► RLS 510/M MX	2040	1180	1125	300
► RLS 610/M MX	2400	1400	1595	320

Low NOx Modulating Dual Fuel Burners

RLS 310÷610/M MX SERIES

Specification

DESIGNATION OF SERIES

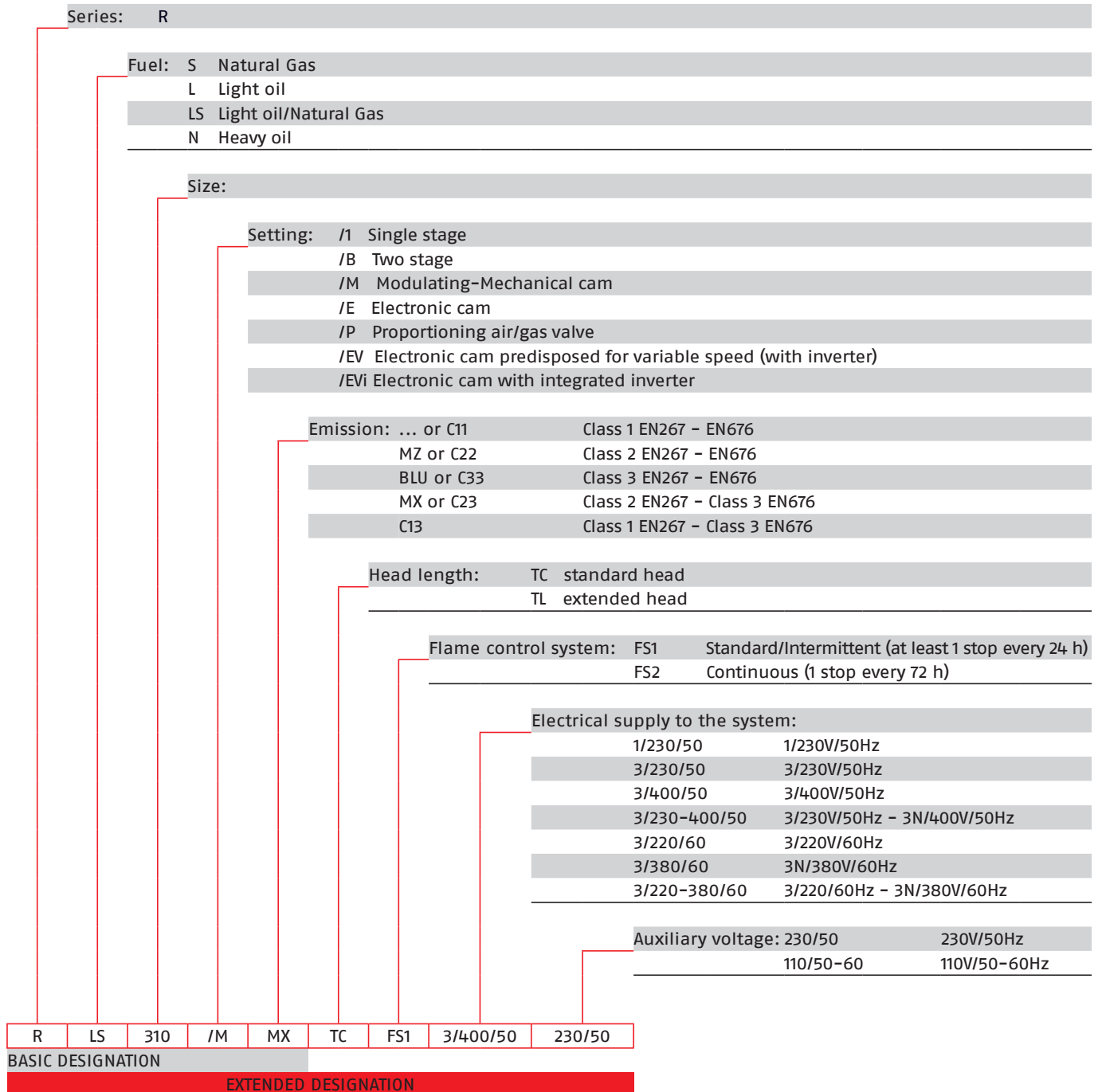

RLS 310÷610/M MX SERIES

Specification

STATE OF SUPPLY

Monoblock forced draught dual fuel burners with modulating operation, fully automatic, made up of:

- High performance fan
- Air suction circuit lined with sound-proofing material
- Air damper for air setting controlled by a high precision servomotor
- Air pressure switch
- Fan starting motor at 2800 rpm, three-phase, 400V, 50Hz
- Low emission combustion head, that can be set on the basis of required output, fitted with:
 - stainless steel end cone, resistant to corrosion and high temperatures
 - ignition electrodes
 - flame stability disk
- Mechanical cam with gas and oil modulator
- Maximum gas pressure switch, with pressure test point, to stop the burner in the case of over pressure on the fuel supply line
- Flame control panel for controlling the system safety - UV flame sensor
- Star/delta starter or direct starter (RLS 310-410) for the fan motor - Main electrical supply terminal board
- Burner on/off switch
- Auxiliary voltage led signal
- Burner working led signal
- Contacts motor and thermal relay with release button
- Motor internal thermal protection
- Motor failure led signal
- Burner failure led signal and lighted release button
- Emergency button
- Coded connection plugs-sockets
- Burner opening hinge
- Lifting rings
- IP 54 electric protection level
- Light oil gears pump for high pressure fuel supply
- Dedicated pump starting motor
- Valve unit with double oil safety valve on the output circuit and double safety valve on the return circuit
- Maximum and minimum oil pressure switches
- Oil pressure gauges on supply and return oil lines
- Oil/Gas selector
- Flame inspection window.

Standard equipment:

- 1 flange gasket for gas train adaptor
- 1 adaptor for gas train
- 4 screws for fixing the flange
- 1 thermal screen
- 4 screws for fixing the burner flange to the boiler
- 2 flexible pipes for connection to the oil supply network
- 2 nipples for connection to the pump with gaskets
- 8 gas nozzles (only for RLS 310/M)
- Instruction handbook for installation, use and maintenance
- Spare parts catalogue.

Low NOx Modulating Dual Fuel Burners

RLS 310÷610/M MX SERIES

Available models

Burners

CODE	MODEL	HEAT OUTPUT			TOTAL ELECTRICAL POWER (kW)	CERTIFICATION	NOTE
		(kW)	LIGHT OIL (kg/h)	NATURAL GAS (Nm ³ /h)			
20147806	RLS 310/M MX TC FS1 3/230/50	600/1200-3600	50/100-305	60/120-360	10,9 (oil) 9,1 (gas)	CE 0085CQ0196	(1)
20147807	RLS 310/M MX TC FS1 3/400/50	600/1200-3600	50/100-305	60/120-360	10,9 (oil) 9,1 (gas)	CE 0085CQ0196	(1)
20147811	RLS 310/M MX TC FS1 3/400/50	600/1200-3600	50/100-305	60/120-360	10,9 (oil) 9,1 (gas)	CE 0085CQ0196	(1)
20147809	RLS 410/M MX TC FS1 3/230/50	640/1500-4200	55/126-352	64/150-420	12,6 (oil) 10,8 (gas)	CE 0085CQ0196	(1)
20147810	RLS 410/M MX TC FS1 3/400/50	640/1500-4200	55/126-352	64/150-420	12,6 (oil) 10,8 (gas)	CE 0085CQ0196	(1)
20147894	RLS 410/M MX TC FS1 3/400/50	640/1500-4200	55/126-352	64/150-420	12,6 (oil) 10,8 (gas)	CE 0085CQ0196	(1)
20147812	RLS 510/M MX TC FS1 3/400/50	660/1800-5170	55/195-435	66/180-517	15,8 (oil) 14 (gas)	CE 0085CQ0196	(1)
20147813	RLS 610/M MX TC FS1 3/400/50	1000/2200-6155	86/185-516	100/220-615,5	18,8 (oil) 17 (gas)	CE 0085CQ0196	(1)

Net calorific value light oil: 11,8 kWh/kg; 10.200 kcal/kg - Viscosity at 20°C: 4-6 mm²/s (cSt).

Net calorific value G20 gas: 10 kWh/Nm³; 8.600 kcal/Nm³ - Density: 0,71 kg/Nm³.

The burners of RLS/M MX series are in according to 2016/426/EU - 2014/30/EU - 2014/35/EU - 2014/68/EU - 2006/42 CE Directive and EN 267 - 676 Norm.

Due to the improvement of the technical specification of some products, some burner codes have been changed. The table below summarizes the correspondence between the previous and the new code.

MODEL	NEW CODE	OLD CODE
RLS 310/M MX TC FS1 3/400/50 (delta - star)	20147811 (1)	20087651 (2)
RLS 310/M MX TC FS1 3/230/50 (230V direct)	20147806 (1)	20087647 (2)
RLS 310/M MX TC FS1 3/400/50 (400V direct)	20147807 (1)	20087648 (2)
RLS 410/M MX TC FS1 3/400/50 (delta - star)	20147894 (1)	20076483 (2)
RLS 410/M MX TC FS1 3/230/50 (230V direct)	20147809 (1)	20087649 (2)
RLS 410/M MX TC FS1 3/400/50 (400V direct)	20147810 (1)	20087650 (2)
RLS 510/M MX TC FS1 3/400/50 (delta - star)	20147812 (1)	20087652 (2)
RLS 610/M MX TC FS1 3/400/50 (delta - star)	20147813 (1)	20087653 (2)

Net calorific value light oil: 11,8 kWh/kg; 10.200 kcal/kg - Viscosity at 20°C: 4-6 mm²/s (cSt).

Net calorific value G20 gas: 10 kWh/Nm³; 8.600 kcal/Nm³ - Density: 0,71 kg/Nm³.

The burners of RLS/M series are in according to 2016/426/EU - 2014/30/EU - 2014/35/EU - 2006/42 CE Directive and EN 676 Norm.

(1) With RFGO control box.

(2) With LFL control box.

RLS 310÷610/M MX SERIES

Available models

Gas Trains

CODE	GAS TRAIN				VPS Code	ADAPTER CODE			
	MODEL	Ø	C.T.			RLS 310	RLS 410	RLS 510	RLS 610
3970180*	MB 415/1 - RT 30	Rp 1" 1/2	-	3010123	3000826 + 20064220	●	●	●	
3970198**	MB 415/1 CT RT 30	Rp 1" 1/2	◆	◆		●	●	●	
3970250*	MB 415/1 - RT 52	Rp 1" 1/2	-	3010123		●	●	●	
3970253**	MB 415/1 CT RT 52	Rp 1" 1/2	◆	◆		●	●	●	
3970232*	MB 415/1 - RSM 30	Rp 1" 1/2	-	3010123	●	●	●		
3970181*	MB 420/1 - RT 30	Rp 2"	-	3010123	3000826 + 20042324	●	●	●	
3970182**	MB 420/1 CT RT 30	Rp 2"	◆	◆		●	●	●	
3970257*	MB 420/1 - RT 52	Rp 2"	-	3010123		●	●	●	
3970252**	MB 420/1 CT RT 52	Rp 2"	◆	◆		●	●	●	
3970233*	MB 420/1 - RSM 30	Rp 2"	-	3010123	●	●	●		
3970234**	MB 420/1 CT RSM 30	Rp 2"	◆	◆	●	●	●		
20137718*	VGD 50/1 - RT 122	Rp 2"	-	3010123+ 20186306	(3000826 + 20042324) / 20068062 (2)			●	
20169190**	VGD 50/1 CT RT 122	Rp 2"	◆	◆	(3000826 + 20042324) / 20068062 (2)			●	
20140762*	VGD 65/1 - FT 122	DN 65 (1)	-	3010123	□				
20169191**	VGD 65/1 CT FT 122	DN 65 (1)	◆	◆	□				
20140763*	VGD 80/1 - FT 122	DN 80	-	3010123	□				
20169192**	VGD 80/1 CT FT 122	DN 80	◆	◆	□				
20169193*	VGD 100/1 - FT 122	DN 100	-	3010123	3010370				
20169194**	VGD 100/1 CT FT 122	DN 100	◆	◆	3010370				
20169195*	VGD 125/1 - FT 122	DN 125	-	3010123	●	3010224			
20169196**	VGD 125/1 CT FT 122	DN 125	◆	◆	●	3010224			

Please see designation of Gas Train Series in the page before the Catalogue index.

* 230V/50Hz - 220V/60Hz electrical supply.

** 230V/50Hz electrical supply.

The valve seal control device is compulsory (conforming to EN 676) on gas trains to burners with a maximum output over 1200 kW.

To select the gas train please refer to the technical data leaflet and/or instruction manual.

(1) Øin = DN 65, Øout = DN 80.

C.T. Gas valve leak detection control device:

- gas train not equipped with leak detection control device; this device can be ordered separately - see VPS column - and installed later.

◆ gas train equipped with leak detection control device.

VPS Valve leak detection control device. Supplied separately from the gas train (please see Gas train accessories paragraph for both 50 Hz and 60 Hz codes).

● Not available.

□ Additional adapter not necessary, the gas train may be connected directly to the burner.

Low NOx Modulating Dual Fuel Burners

RLS 310÷610/M MX SERIES

Burner accessories

Nozzles

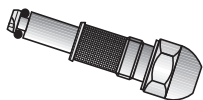

Return nozzles without needle are used on RLS/M MX burners. The nozzle must be ordered as accessory. The following table shows the features and codes on the basis of the maximum required fuel output.

BURNER	RATED DELIVERY (kg/h)	NOZZLE CODE ⁽¹⁾	NOZZLE CODE ⁽²⁾
▶ RLS 310-410/M MX	150	3009314	3045479
▶ RLS 310-410/M MX	175	3009316	3045481
▶ RLS 310-410/M MX	200	3009318	3045483
▶ RLS 310-410/M MX	225	3009320	3045485
▶ RLS 310-410-510/M MX	250	3009322	3045487
▶ RLS 310-410-510/M MX	275	3009324	3045489
▶ RLS 310-410-510-610/M MX	300	3009326	3045491
▶ RLS 310-410-510-610/M MX	325	3009328	3045493
▶ RLS 310-410-510-610/M MX	350	3009330	3045495
▶ RLS 310-410-510-610/M MX	375	3009332	3045497
▶ RLS 310-410-510-610/M MX	400	3009334	3045499
▶ RLS 310-410-510-610/M MX	425	3009336	3045500
▶ RLS 510-610/M MX	450	3009338	3045501
▶ RLS 610/M MX	475	3009340	-
▶ RLS 610/M MX	500	3009342	3045503
▶ RLS 610/M MX	525	3009344	-
▶ RLS 610/M MX	550	3009346	3045505
▶ RLS 610/M MX	575	3009348	-
▶ RLS 610/M MX	600	3009350	3045507

⁽¹⁾ Nozzle Bergonzo type B5 45° SA

⁽²⁾ Nozzle Fluidics type N2 45°

For more information please contact Riello Burners Commercial and Technical Department, our Application Engineers will be pleased to help you.

RLS 310÷610/M MX SERIES

Burner accessories

Accessories for modulating operation

POWER CONTROLLER



To obtain modulating operation, the RLS/M MX series of burners requires a regulator.
For remote setpoint use RWF 55.

BURNER	REGULATOR TYPE	REGULATOR CODE
▶ All models	RWF 50.2 - Basic version with - 3 position output	20073595
▶ All models	RWF 55.5 - Complete with RS-485 interface	20074441
▶ All models	RWF 55.6 - Complete with RS-485/ PROFIBUS interface	20074442

PROBE



The relative temperature or pressure probes fitted to the regulator, must be chosen on the basis of the application.

BURNER	PROBE TYPE	RANGE (°C) (bar)	PROBE CODE
▶ All models	Temperature PT 100	-100 ÷ 500°C	3010110
▶ All models	Pressure 4 ÷ 20 mA	0 ÷ 2,5 bar	3010213
▶ All models	Pressure 4 ÷ 20 mA	0 ÷ 16 bar	3010214

ANALOG CONTROL SIGNAL CONVERTER



BURNER	TYPE (INPUT SIGNAL)	KIT CODE
▶ All models	0/2 - 10 V (impedance 200 KΩ) 0/4 - 20 mA (impedance 250 Ω)	20074479

POTENTIOMETER



BURNER	KIT CODE
▶ All models	20096322

It is necessary for analogic control signal converter operation.

Fuel remote selection kit



BURNER	KIT CODE
▶ All models	-

Low NOx Modulating Dual Fuel Burners

RLS 310÷610/M MX SERIES

Burner accessories

Continuous ventilation kit



If the burner requires continuous ventilation in the stages without flame, a special kit is available as given in the following table:

BURNER	KIT CODE
► All models	20074542

Sound proofing box

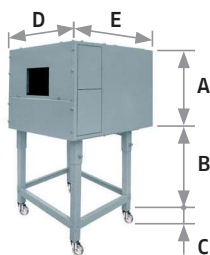

If noise emission needs reducing even further, sound-proofing boxes are available. When a lower "B" dimension is required, it is available the Box Support Kit code 20065135 which allows to reduce it at the fixed dimension of 55 mm. The sound-proofing boxes are not suitable for outdoor use.

BURNER	BOX TYPE	A (mm)	B (mm) min-max	C (mm)	D (mm)	E (mm)	[dB(A)] (*)	BOX CODE
► RLS 310-410/M	C7	1255	160 - 980	110	1140	1345	10	3010376
► RLS 510-610/M	C7 Plus	1255	160 - 980	110	1240	1345	10	20085111

(*) Average noise reduction according to EN 15036-1 standard

Spacer kit



If burner head penetration into the combustion chamber needs reducing, varying thickness spacers are available, as given in the following table:







BURNER	SPACER THICKNESS S (mm)	KIT CODE
► All models	180	20008903

RLS 310÷610/M MX SERIES

Gas train accessories

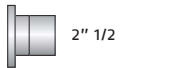
Adapters

In certain cases, an adapter must be fitted between the gas train and the burner, when the diameter of the gas train is different from the set diameter of the burner. Below are given the available adapters; please see on the Gas Train list the correct adapter codes to select.

ADAPTER	DIMENSIONS			ADAPTER CODE
	Ø1 DN	Ø2 DN	A mm	
1" 1/2  2"	-	-	65	20064220
2"  2"	-	-	65	20042324
DN 80  2"	-	-	300	3000826
DN 100  DN 80	100	80	50	3010370
DN 80/65  2"	2"	65/80	780	20068062
	125	80	320	3010224

Seal control kit



To test the valve seals on the gas train, a special "seal control kit" is available. The valve seal control device is compulsory (EN 676) on gas trains to burners with a maximum output over 1200 kW. The seal control is type VPS 504.

GAS TRAIN	KIT CODE for 50 Hz operation
▶ MB type	3010123
▶ VGD 50/1	3010123+20186306
▶ VGD 65/1 - 80/1 - 100/1 - 125/1	3010123

Stabiliser spring



To vary the pressure range of the gas train stabilisers, accessory springs are available. The following table shows these accessories with their application range. Please refer to the technical manual for the correct choice of spring.

GAS TRAIN	SPRING COLOUR	SPRING PRESSURE RANGE mbar	SPRING CODE
▶ VGD/1 series	Neutral	0 - 22	20181839
	Yellow	15 - 120	20141900
	Red	100 - 250	20141901